



CR2477 *Brief Datasheet*

Lithium Manganese Dioxide Coin Batteries

1 BASIC SPECIFICATION

Nominal Voltage(V)	3.0
Nominal Capacity(mAh) Continuous discharge with 15kΩ to 2.0V cut-off, +23°C	850
Continuous standard load (kΩ)	15
Operating temperature (°C)	-20~+70
Weight (g)	8.4

Note: Typical values relative to cells stored for three months at 23 °C.

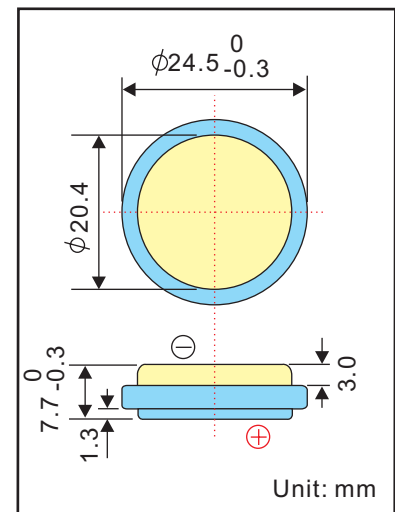

2 MAIN FEATURES

- ◆ Light Weight, High Voltage and High Energy Density.
- ◆ Excellent Stable Discharge Characteristics and outstanding Temperature Characteristics.
- ◆ Excellent Leakage Resistance and Excellent Long-term Reliability.

3 ELECTRICAL CHARACTERISTICS

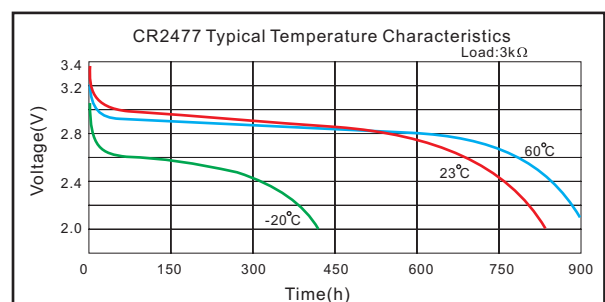
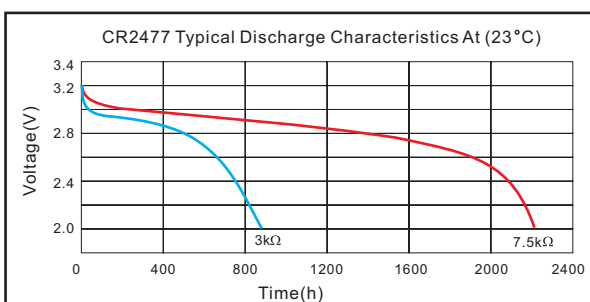

4 WARNING!

- ◆ Do not recharge, short-circuit, disassemble, deform, heat or place the battery near a direct flame. Any of the above actions could cause it to ignite explode or become damaged.
- ◆ Keep this battery out of the reach of children.
- ◆ When storing the battery or throwing it away, be sure to cover it with tape.

Note: Any representations in this brochure concerning performance, are for informational purposes only and are not construed as warranties either expressed or implied, of future performance.