

LIR18500 Lithium Ion Battery

Brief Datasheet

1 Dimension

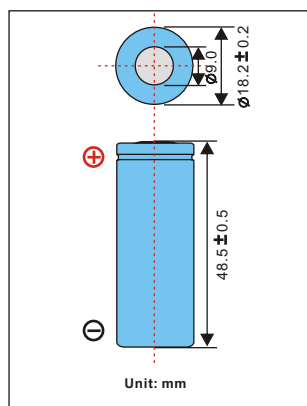

3 Electrical Characteristics

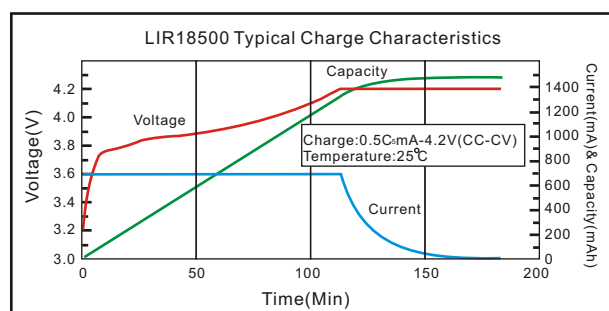

2 Basic Specification

Nominal Voltage		3.7V
Nominal Capacity	Typical	1400mAh (0.2C discharge)
	Minimum	1350mAh (0.2C discharge)
Charge method		CC/CV (Constant Current-Constant Voltage) current: 0.5C Voltage: 4.2V End current: 20mA
Charging Voltage		4.20V±0.05V
Charging Std. Current		700mA
Max Current	Charge	1400mA
	Discharge	2800mA
Ambient Temperature	Std. Charge	-20°C to 45°C
	Discharge	-20°C to 60°C
	Storage	-5°C to 35°C
Discharge cut-off voltage		2.75V
Internal Impedance		<80mΩ
Cycle life		>300cycles(≥80% capacity)
Nominal Weight		Approx. 33g

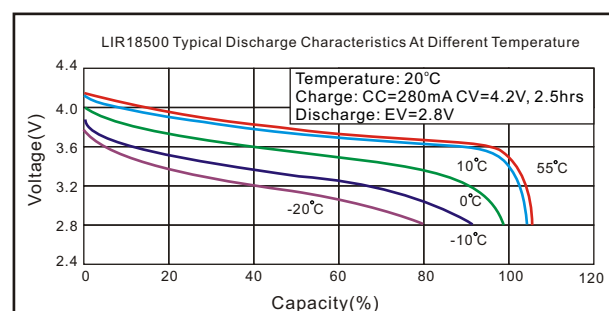
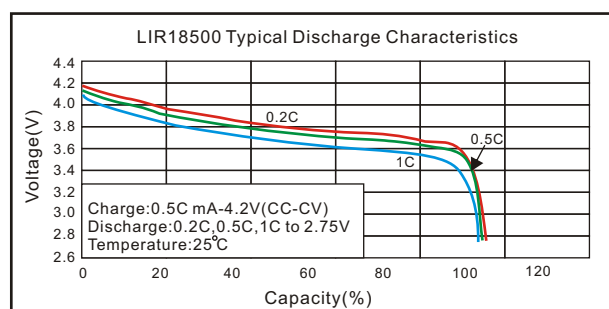

Note: *1C = 1 Capacity

Note: Any representations in this brochure concerning performance, are for informational purposes only and are not construed as warranties either expressed or implied, of future performance.